



# Pearl Genuine Parts and Accessories

For every Pearl product, there are genuine Pearl replacement parts. Within this catalog you will find the parts and accessories you need to keep your drums "Genuine Pearl".



*Pearl*

# Drum Accessories

## TOM HOLDERS

The TH-98 series tom holders feature Pearl's infinitely adjustable Uni-Lock system for pin-point tom positioning. The TH-98I features a 25mm shorter arm for use with suspension mounting systems.

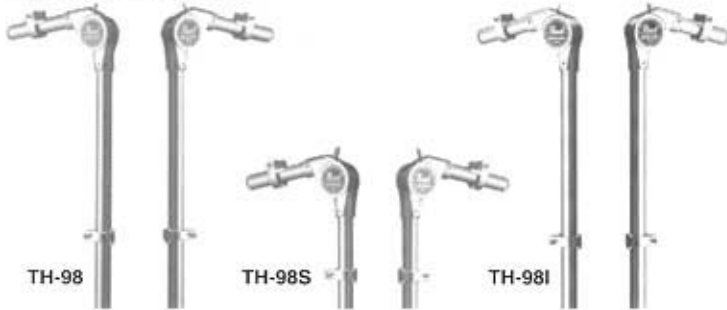

TH-86 series tom holders are identical to the TH-98 series but feature gear filters instead of Uni-Lock.

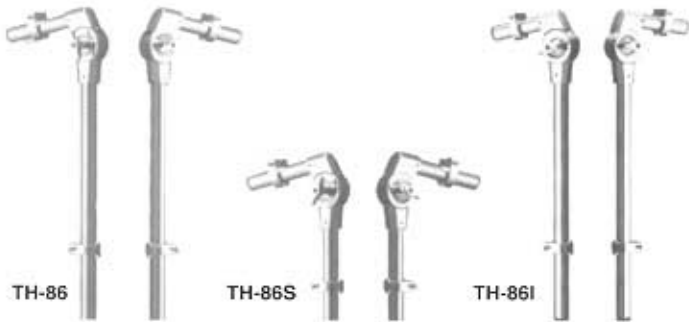

## CYMBAL HOLDERS

Pearl offers cymbal holders for every application whether rack or adapter mounted. The CH-88L features an extended boom arm with counter weight for added versatility and "reach". The CH-80 and the light weight CH-75 feature gear filters.



### CH-70

The CH-70 combines a cymbal boom arm and quick release mounting bracket into an easy to use and versatile package.

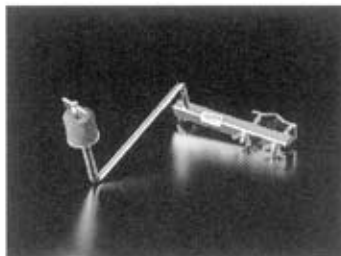
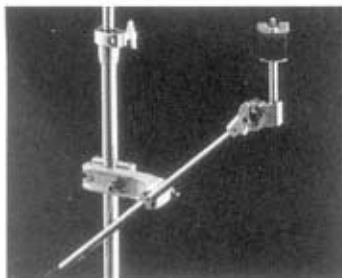

### APS-31

The APS-31 features a pivoting cymbal arm for accurate cymbal placement. The integrated bracket fits tubing from 3/4" to 1-1/8".



### AJ-96

The AJ-96 boom tom arm extends the "reach" and angling possibilities of toms especially when used with drum racks.

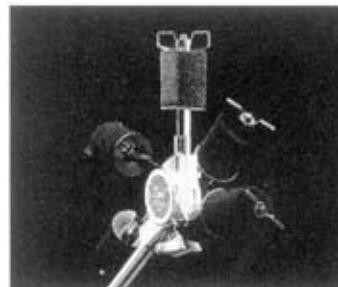
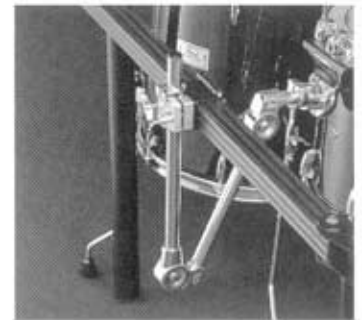

### UNI-LOCK TILTER

CH-88L and CH-88 feature infinitely adjustable Uni-Lock fillers for exact cymbal positioning.



### STOP-LOCK

CH-88L, CH-88 and CH-80 cymbal holders feature Stop-Locks on the boom arms and main tubes for quick set-ups and slip prevention.

## PIPE CLAMPS

PC-50 and PC-5 clamps are compatible with all current Pearl drum racks (except DR-80). PC-50 clamps accommodate 7/8" diameter cymbal and tom holders; PC-5 clamps feature adjustable jaws. PC-8 clamps are compatible with DR-80 drum racks and accommodate 7/8" tubing. All Pearl Pipe Clamps feature quick release mounting.

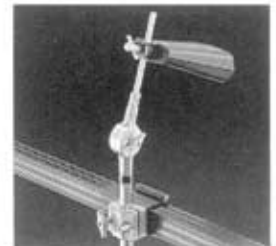

## ADAPTERS

### AX-20

The AX-20 features dual quick release clamps for attachment to vertically all commonly used tubing. Superior quality alloys and high-pressure molding assure years of dependable and trouble-free service.

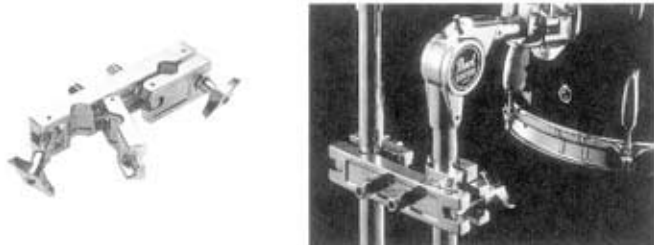

### AX-25/AX-25L

The AX-25/25L feature rotating quick release jaws for vertically unlimited positioning possibilities. Both jaws are adjustable to accommodate a wide range of tubing sizes. Superior quality alloys and high-pressure molding assure years of dependable and trouble-free service.

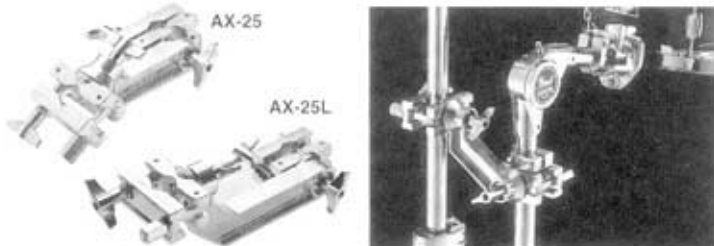

### AX-35

The AX-35 features three quick release clamps for attachment to commonly used tubing diameter. Superior quality alloys and high-pressure molding assure years of dependable and trouble-free service.

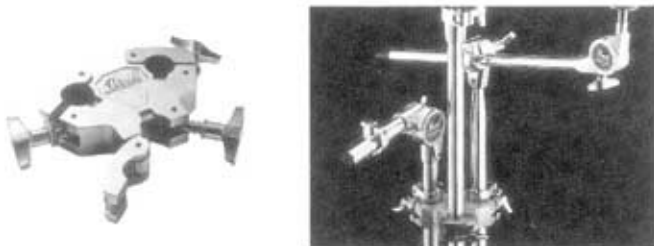

## COWBELL FOOT PEDAL BRACKET

### APS-15

The APS-15 allows cowbells and other percussive sounds to be played by foot thus "freeing" the hands to play complex rhythms not before possible.

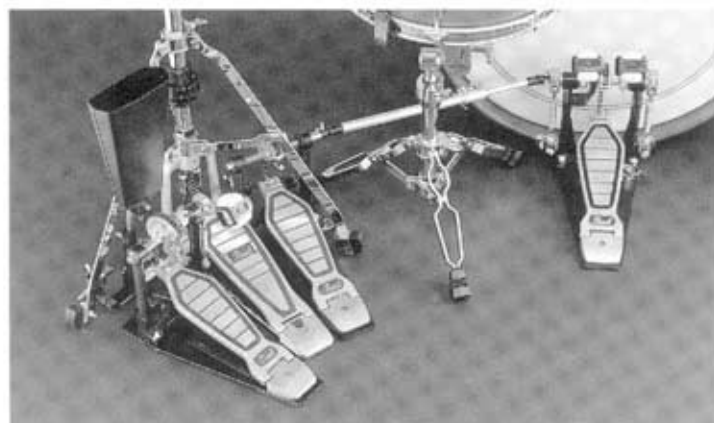
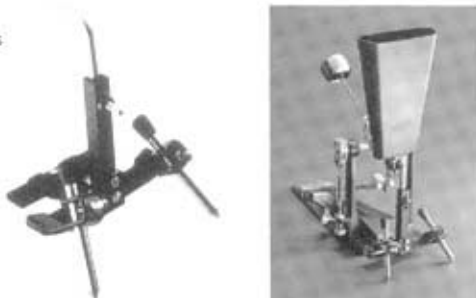

## HI-HAT ATTACHMENT

### HA-95L

The HA-95L allows the hi-hat to be placed next to the bass pedal on double bass set-ups for easy reach and fast pedal transitions.

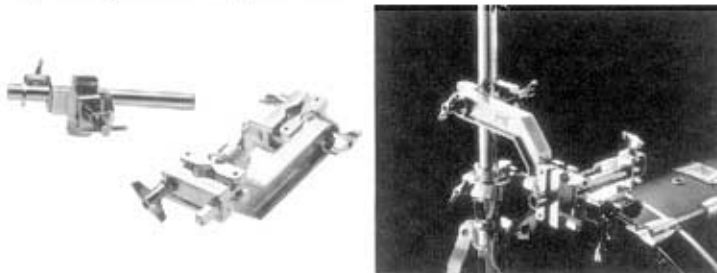

## CLOSED HAT

### CLH-95A

The CLH-95A adds "closed hi-hats" to your set-up. 7-way angling assures perfect hi-hat placement. The cymbals are closed from the top for quick and easy tension adjustments.

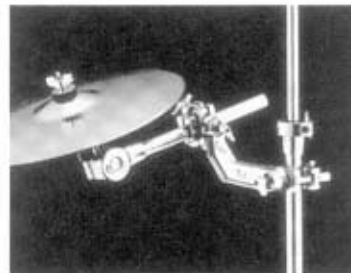

## COWBELL HOLDERS

### 75H

The 75H hoop mounted cowbell holder features parallel action jaws for superior clamping power. The control plate is rubber lined to help prevent slippage and to protect the hoop from nicks and scratches.



### 75X

The 75X features a tilting post and 7/8" tube for use with drum racks and adapters.

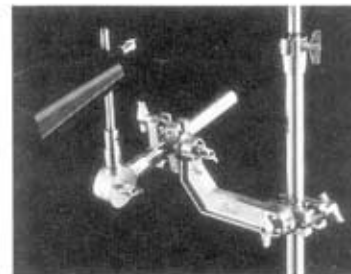

### APS-37

The APS-37 features a fully adjustable "L" arm for mounting cowbells, effects, and drums (equipped with 3/8" receivers). The gear tiller grips securely and permits infinite angling possibilities. The integrated quick release bracket facilitates fast set-ups and removal.

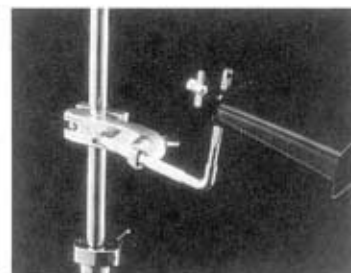

### APS-30

The APS-30 is a universal percussion mounting bracket that can be attached to any tubular stand with diameters of 4/3" to 1-1/8".



# Bass Drum Parts

## BASS DRUM SPURS

### SP-30

The SP-30 features "set and forget" fold away spurs with twist-lock retractable spike/rubber tips. Sold in sets of two.

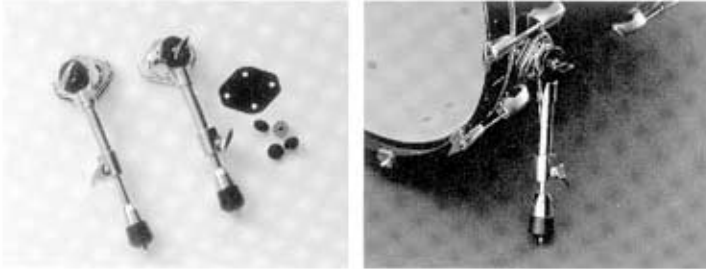

### SP-20

SP-20 spurs feature fold away telescopic points with spike/rubber tips. Sold in sets of two.

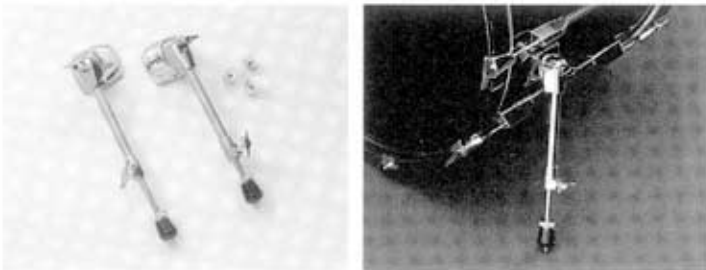

## RUBBER TIPS

### R-30A



### R-30A

Rubber tips for SP-30 spurs. Sold in pairs.

### RHS-1R



### RHS-1R

Rubber tips for SP-20 spurs. Sold in pairs.

## BASS DRUM TENSION RODS & CLAW HOOKS



- T-075 Die-cast tension handle bolt (M6 x 110mm)
- T-080 T-rod for bass drum (M6 x 110mm)
- T-066 Key rod for bass drum (M6 x 110mm)
- D-050 Die-cast claw hook (Masters)
- D-043 Claw hook (Export)

## BASS DRUM BRACKET

### BB-3

The BB-3 accepts all holders and accessories using 7/8" tubing. The dual brackets feature slip resistant nylon sleeves and Stop-Lock receivers.



## BASS DRUM HOOPS

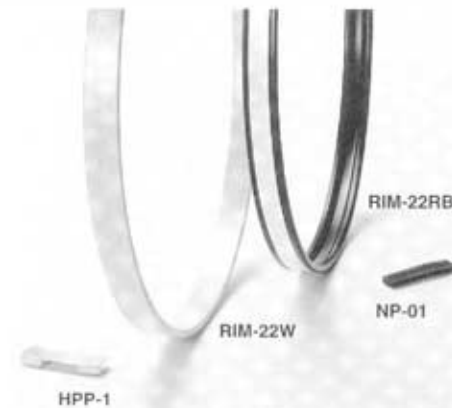

### RIM-22W

Pearl bass drum hoops feature premium 8 ply maple construction and super high gloss lacquer finishes. Sizes : 18" to 24".

### RIM-22RB

Steel bass drum hoops feature black lacquer finish and a choice of color inlays. Size : 18" to 24".

### HPP-1

The HPP-1 protects wood hoops from nicks and scratches during pedal attachment and detachment.

### NP-01

The NP-01 installs into the channel of steel brass drum hoops and provides a slip-resistant surface for bass pedal attachment.

## BASS DRUM HEADS

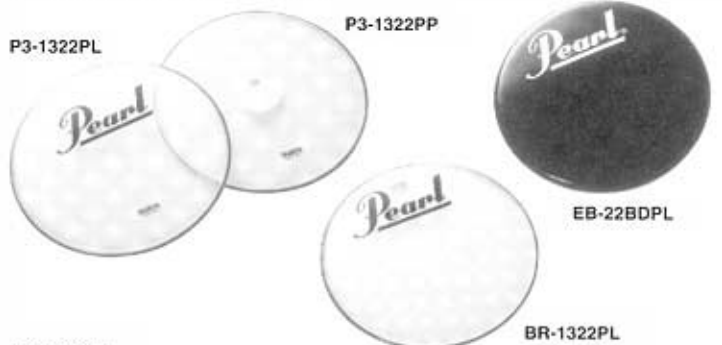

### P3-1322PL

22" Remo Powerstroke3 Masters Series BD head w/Pearl Logo

### P3-1322PP

22" Remo Powerstroke3 Masters Series BD head, batter

### EB-22BDPL

22" Black Beat BD head w/Pearl Logo

### BR-1322PL

22" Remo Clear Ambassador w/Pearl Logo



# Floor Tom Parts

## FLOOR TOM LEG & BRACKET

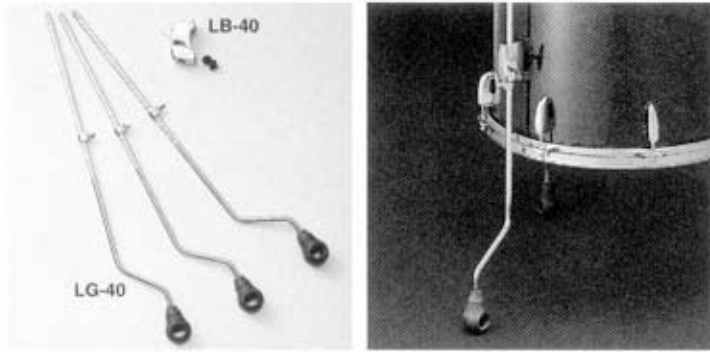

**LB-40** Masters floor tom leg bracket.

**LG-40** Floor tom leg featuring the new Air Suspension rubber tip.  
Sold in packs of 3.

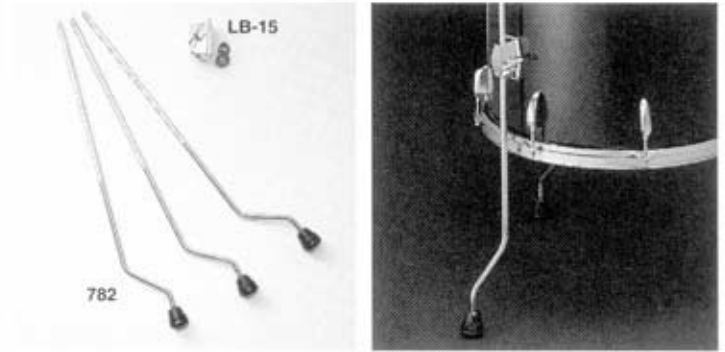

**LB-15** Floor tom leg bracket, standard.

**782** Floor tom leg. Sold in packs of 3.

## FLOOR TOM RUBBER TIPS

### R-40

New! Air Suspension rubber tip (PAT. PEND.). Substantially improves sustain and resonance of floor toms. Fits all 3/8" diameter floor tom legs.  
(Sold in packs of 3)

### R-5

New soft compound rubber tip for 782 floor tom leg.  
(Sold in packs of 3)



# Tom Tom Parts

## I.S.S. / INTEGRATED SUSPENSION SYSTEM

(PATENTED/US. PAT #5,544,561)

The Integrated Suspension System attaches the tom bracket to the rim of the drum thus permitting the shell to vibrate freely for maximum sustain and resonance. The I.S.S. removes easily for quick drum head changes.

### IS-0810

Fits 8" to 10" 1.6mm steel hoops and 2.3mm Super hoops.

### IS-1216

Fits 12" to 16" 1.6mm steel hoops.

### IS-1216S (not shown)

Fits 12" to 16" 2.3mm Super hoops.



### IS-0810SL

Fits 8" to 10" 2.0mm steel/stainless steel hoops and 2.3mm Super Hoop II.

### IS-1216SL

Fits 12" to 16" 2.0mm steel/stainless steel hoops and 2.3mm Super Hoop II.



## TOM TOM BRACKET

### BT-3

The BT-3 accepts all holders using 7/8" tubing and features an internal non-marring nylon sleeve for slip resistance. Stop-Lock compatible.



## MASKING COVER

### GK-90

The GK-90 masks the holes (inside and out) on the drums where the BT-3 tom bracket has been removed.



## SUPER HOOP II



Model #	Diameter	Tension
SH-0805	8	5
SH-1006	10	6
SH-1206	12	6
SH-1306	13	6
SH-1408	14	8
SH-1410	14	10, Batter Side
SH-1410S	14	10, Snare Side
SH-1410SG	14	10, Snare Side w/Guard
SH-1508	15	8
SH-1608	16	8
SH-1808	18	8

## TENSION RODS & WASHERS



**T-055** Tension Key rod - M5.8 x 28mm (Sold in packs of 6)  
**T-060** Tension Key rod - M5.8 x 35mm (Sold in packs of 6)  
**T-061** Tension Key rod - M5.8 x 42mm (Sold in packs of 6)  
**T-062** Tension Key rod - M5.8 x 52mm (Sold in packs of 6)  
**NLW-12** Nylon washer (Sold in packs of 12)  
**MTW-12** Metal washer (Sold in packs of 12)

# Snare Drum Parts

## STRAINERS

Pearl strainers are engineered to pull the snare string/straps parallel to the shell, not at an angle like others. Vertical Pull action achieves ideal snare/head contact with minimal tension resulting in superior snare response without choking...at all volume.



### SR-010

For Free Floating System snare drums. Butt-side tension adjustment helps center snares. Package includes strainer and butt.

### SR-012

Features vertical pull design and side action lever. Package includes strainer and butt.

### SR-015

Gladstone-type strainer features vertical pull design. Package includes strainer and butt.

### SR-016

Piccolo/Sopranino strainer. Package includes strainer and butt.



### SR-020

Multi-trace strainer features click-stops for instant changes from tight, medium and loose snare settings. Package includes strainer and butt.



## DIE-CAST HOOPS



Model #	Diameter	Tension
DC-14T	14	10, Batter Side
DC-14B	14	10, Snare Side

## DRUM KEYS



**K-025** Standard drum key.  
**K-029** Speed drum key.

## HIGH CARBON STEEL SNARES

Pearl snares feature high carbon steel wires for extreme sensitivity and superior durability. The strings fit into "tunnels" that allow the snares to contact the head along their full length for improved snare sound.

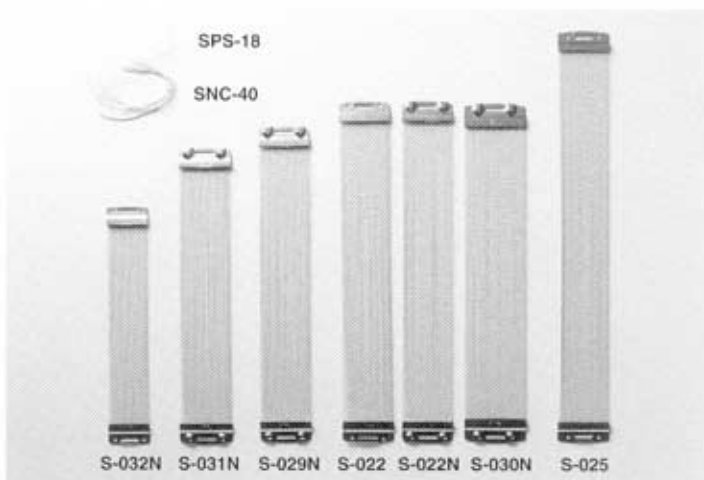

Model #	Strands	Size
S-022	20	14"
S-022N	20	14"
S-025	20	14" long
S-029N	20	13"
S-030N	24	14"
S-031N	20	12"
S-032N	12	10"
S-033N	12	12"

⊕ not shown

### SPS-18

Replacement snare straps (Sold in packs of 6)

### SNC-40

Our snare string is specially made with 200 strands of Dacron for incredible stretch resistance. Sold in packs of 6.

## Outside Muffler

### OM-1

The OM-1 is an external clamp-on muffling device for snare drums and toms. By adjusting the position (close or far from the rim) and the pressure of the felt pad, drum "ring" can be precisely controlled or eliminated.

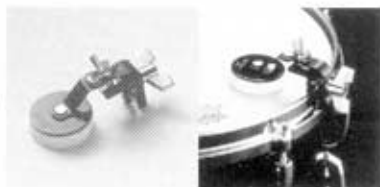

## SNARE BASKET ADAPTER



### SBA-1

The SBA-1 works with all Pearl snare stands to accommodate 12" snare drums such as the M-712SE and M-412SN. Sold in sets of three.

# Stand Parts

## CYMBAL TILTERS



### M-8W

8mm die-cast wing nut for cymbal stands. Fits Pearl, Gibraltar, DW, etc. Sold in packs of 6.

### FL-90

Large felt washers. Fits all cymbal / boom stands. Sold in packs of 2.

### FL-85

Medium felt washers. Fits all cymbal / boom stands. Sold in packs of 2.

### NP-69

Plastic sleeves. Fits Pearl, Gibraltar, DW, etc. Sold in packs of 2.

### PR-135

Steel cup washer.

## BOLT & NUTS (Sold in packs of 6)

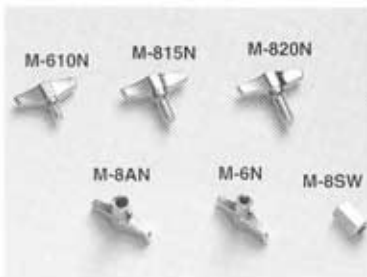

**M-610N** (M6x10mm) Die-cast wing bolt.

**M-815N** (M8x15mm) Die-cast wing bolt.

**M-820N** (M8x20mm) Die-cast wing bolt.

**M-6N** (M6) Die-cast wing nut

**M-8AN** (M8) Die-cast wing nut

**M-8SW** (M8) Hexagonal nut

## RUBBER TIPS

(Sold in packs of 3)



# Pedal Parts

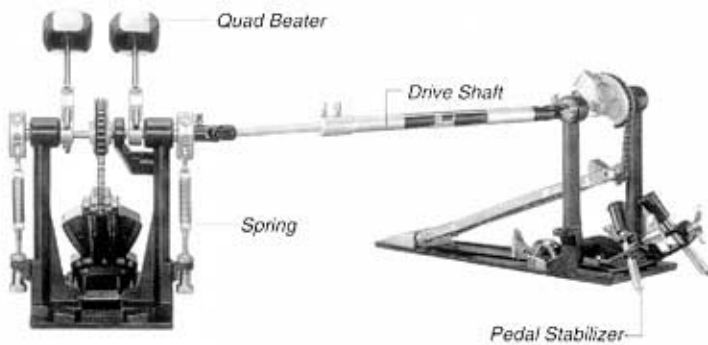

## ALUMINUM DRIVE SHAFT

**DS-95A** The DS-95A double pedal drive shaft features aircraft aluminum components for strength, low weight, and improved speed.

**KB-508** M5 x 8mm key bolt (Sold in packs of 6)

**KB-610** M6 x 10mm key bolt (Sold in packs of 6)



## QUAD BEATER

### B-200QB

The Quad Beater (PAT.PEND) features two plastic and two felt faces, each capable of a different sound.



Face	Face Material	Contact Area	Sound
A	Felt	Spot	Warm with sharp attack
B	Felt	Line	Warm with fat attack
C	Plastic	Spot	Hard with sharp attack
D	Plastic	Line	Hard with fat attack

## SPRING & KEY BOLTS

### SP-31

Standard pedal spring with felt. Engineered for quick action and extended life.

### KB-814

Key bolt for beater holder link (Sold in packs of 3)



## PEDAL STABILIZER

### PS-85

The PS-85 attaches to the secondary pedal of most double pedals and adds stability and slip prevention.



# Hi-Hat Stand Parts

## HI-HAT CLUTCHES

### CL-98P / CL-98

The CL-98P features minimal contact rubber washers for improved "chick-sound", clarity, and increased volume. CL-98 series hi-hat clutches are machined with a concave center bore. This allows the clutch to engage the pull rod at three points: the top and bottom of the clutch and at the bolt tip. The Pearl Triple Lock system assures non-slip clutch performance.



### CL-68

Basic hi-hat clutch with die-cast wing bolt.



## DROP CLUTCH

### DCL-90

The DCL-90 Drop Clutch allows hi-hats to be played "closed" without foot pressure thus freeing the foot to play double bass and/or other pedals. Normal play is resumed by simply stepping on the footboard.



## HI-HAT UPPER SECTION



**NP-208** The NP-208 suspends the bottom hi-hat cymbal on minimal contact rubber "fingers" for improved clarity and sustain. Fits all hi-hat stands.

**NP-210** The NP-210 features minimal contact, conical-shaped rubber washers for improved clarity and "chick" sound of all hi-hat cymbals. Sold in sets of 2.

**FE-17** Standard bottom felt washer.

**FL-95** Standard felt clutch washers. Sold in sets of 2.

**PR-128** Steel bottom washers.

**HHC-1** Hi-hat seat cup with filter screw and spring.

**ME-145** 7mm dia. top pull rod. Fits Pearl, Gibraltar, DW, etc.

# Practice Kits

## TRAINING DRUM KITS

### TK-100

The TK-100 5 piece Practice Pad Set features high-density, super quiet rubber pads for realistic feel and action.

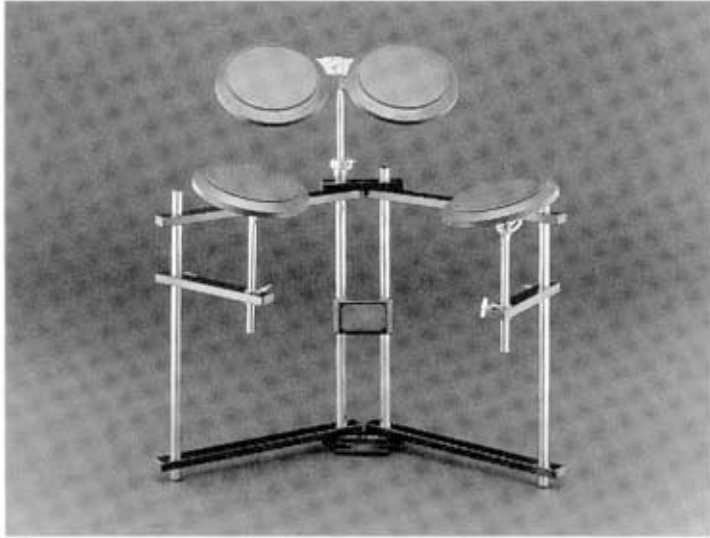

### TK-200

Double bass version of the TK-100.

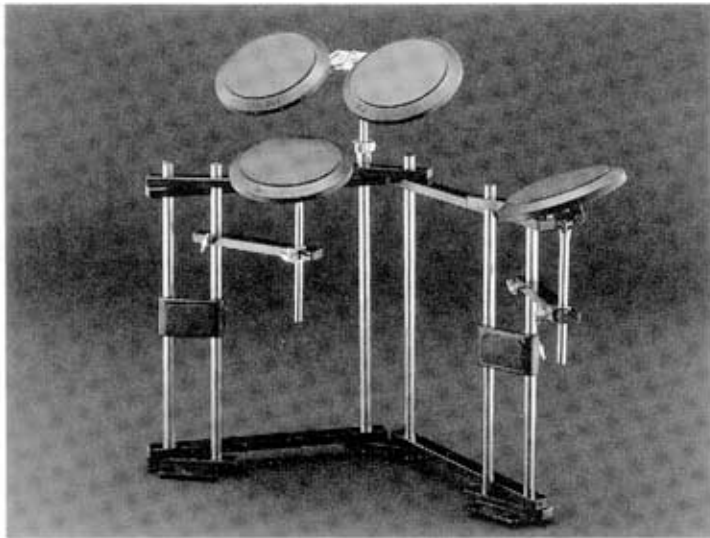

## TRAINING DRUM PAD

### SD-50H

Single version of the same great feeling pads featured on the TK-100/200. Stand included.



## BASS DRUM PEDAL TRAINING PAD

### BD-10

The BD-10 is compact and highly stable. The newly designed pad is extremely quiet and accommodates double pedals. The frame folds for easy transport.



## SILENCER RUBBER PADS

### RP-50

RP-50 mufflers mount onto the heads of any standard 5 piece drum set and consists of a universal-fit bass pad; 14" snare; and 12", 13" and 16" tom pads. Removes in seconds for resumption of "live" play.

### RP-40C

RP-40C mufflers easily mount onto cymbals for silent practicing. Consists of two 18"/20" cymbal pads and a pair of 14" hi-hat pads.

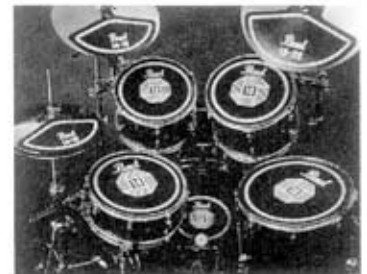

### RP-50

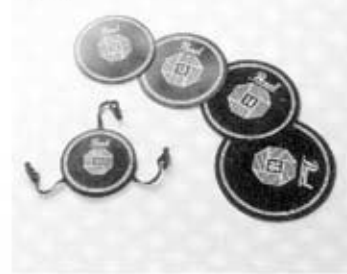

### RP-40C

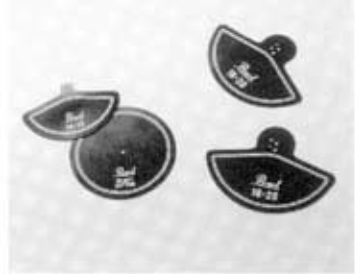

*Pearl*<sup>®</sup>

The best reason to play drums.

Specifications are subject to change without notice. JAN. 1997 printed in Japan 081079 AD.